

AIRMUSEN
2024

广东爱木森压缩机科技有限公司
Guangdong AIRMUSEN Compressor Technology Co., Ltd.

OIL FREE
MEDIUM PRESSURE
HIGH PRESSURE
AIR COMPRESSOR

AIRMUSEN

SINCE 2006

AIR COMPRESSOR

Guangdong AIRMUSEN Compressor Technology Co., Ltd.

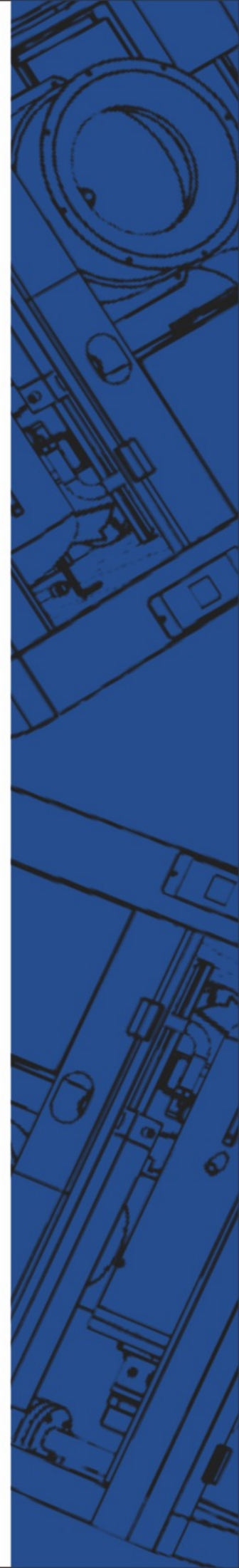

LUCID WATERS AND LUSH MOUNTAINS ARE INVALUABLE ASSETS.

碧水青山是无价之宝



广东爱木森压缩机科技有限公司，致力于空气压缩机、压缩空气后处理及周边设备的研发、生产和销售，为压缩机用户提供可持续的、节能的压缩空气及干燥净化系统解决方案。我们以“纯净空气·爱护森林·爱护自然”为宗旨，按照高品质和高工艺要求，助力客户实现可持续发展的目标，并在复杂多变的市场中不断突破和自我成长。

公司多年来不断努力发展，现主要生产的产品有无油中高压空压机、有油中高压空压机、中高压螺杆增压空压机、螺杆机、后处理净化设备等，生产各种气体压缩机如空气、氮气、氩气、氦气、氢气、二氧化碳等工艺气体，可根据特定要求，定制各种气体压缩机。

Guangdong AIRMUSEN Compressor Technology Co., Ltd. is committed to the research and development, production, and sales of air compressors, compressed air post-treatments, and other related accessory equipment, providing sustainable and energy-saving compressed air drying and purification system solutions for compressor users. Our mission is to Purify Air, Cherish Forest and Treasure Nature. Under the high quality and fine craftsmanship requirements, we are aiming to assist our customers in achieving their sustainable development goals and empower them to continuously make breakthroughs and gain self-growth in this complex and ever-changing market.

Our company has been striving for development in the past decades, with focuses on products such as Oil-free Medium and High Pressure Air Compressors, Medium and High Pressure Air Compressors, Medium and High Pressure Screw and Piston Booster Air Compressors, Screw Air Compressors, Compressed Air Purification Treatment Systems, etc. Compressors for other sort of gases like Nitrogen, Argon, Helium, Hydrogen, Carbon Dioxide are also among our catalogs. Customized compressor proposals for various gas could be offered based on any specific requirements. Feel free to contact us for your very tailor-made air compressor plans.

MEDIUM PRESSURE HIGH PRESSURE AIR COMPRESSOR SYSTEM

中高压空气系统

低压无油空压机气体流量范围: $6\text{m}^3/\text{min}-35\text{m}^3/\text{min}$

Low pressure oil free air compressor flow rate range: $6\text{m}^3/\text{min}-35\text{m}^3/\text{min}$

工作压力范围: 2Bar -16Bar

Pressure range: 2Bar -16Bar

中压无油空压机气体流量范围: $6\text{m}^3/\text{min}-50\text{m}^3/\text{min}$

Medium pressure oil free air compressor flow rate range: $6\text{m}^3/\text{min}-50\text{m}^3/\text{min}$

工作压力范围: 16Bar -40Bar

Pressure range: 16Bar -40Bar

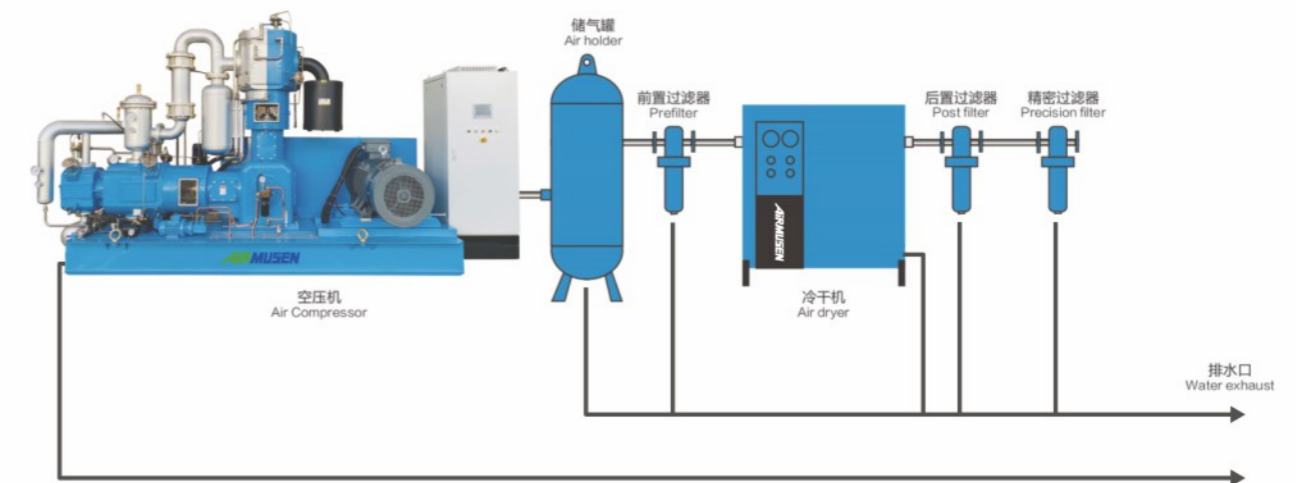

PRODUCT FEATURES

产品特点

采用三级压缩，更方便维护保养，降低客户的维护成本:

一级运行能耗占整机能耗的占比大，利用垂直结构采用双作用降低能耗。
采用L型结构简单，转速低，运动部件少，维护成本低。

Three stage compression, easier to maintain, lower the cost of maintenance.

The energy consumption of the first compression stage accounts for a large proportion of the overall energy consumption, and the vertical structure is used to reduce energy consumption through dual action.

Adopting L type, simple structure, low rotated speed, few moving parts, and low maintenance cost.

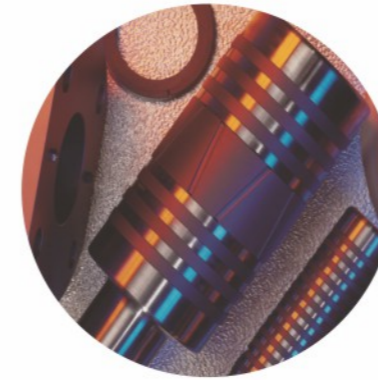
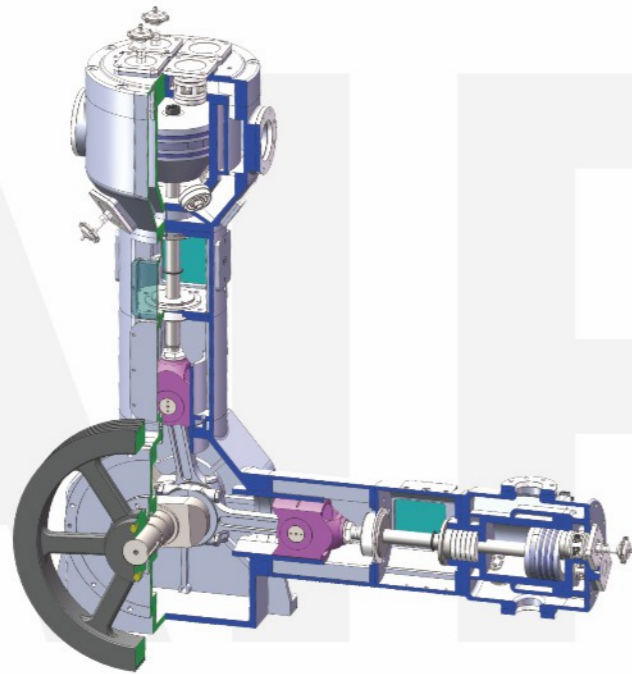

可靠的运动部件 Reliable moving parts

为保障压缩机24小时不间断安全运行。爱木森选用合成PEEK高密封气阀部件，为用户提供气源。

To ensure compressor safety operation, even 24 hours continuous working, AIRMUSEN use peek high seal air valve parts to provide users compressed air source.



精密耐用的零部件 Precision durable parts

采用高效、低噪音的气阀活塞以及各种环和各种密封圈材料。

Adopting efficient and low-noise air valves, pistons, as well as various rings and sealing ring materials.



方便维护保养 Easier to maintain

采用L型结构简单，转速低，运动部件少，维护成本低。

Adopting L type, simple structure, low rotated speed, few moving parts, and low maintenance cost.

AIR COMPRESSOR

L系列中高压无油压缩机

Medium and High pressure oil free compressor L series



远程监控、控制系统(用户选配)。

可以通过手机APP控制，也可以采用物联网控技术24小时可以通过移动端掌握自己的机器设备运行状态。

变频器可以使运行能耗减少1/2，半载功能又可以将总的能耗降至满载的1/4。

Remote monitoring and control system(user optional)

Control through a mobile app, or use IOT technology to control the running status of your equipment 24 hours a day through the mobile end.

The frequency converter can reduce operating energy consumption by half, and half load function can also even reduce the total energy consumption to 1/4 of full load.

外形尺寸 Dimension

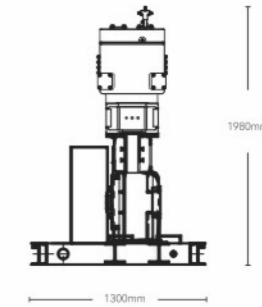
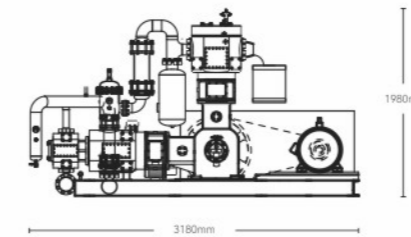
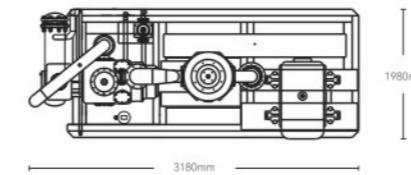

容积流量: 6m³/min、8m³/min
排气压力: 40Bar

FAD: 6m³/min、8m³/min
Pressure: 40Bar

技术参数 Technical Parameters

型号 / Models	LHW-06/40	LHW-08/40
排气量 / Flow rate(m ³ /min)	6	8
排气压力 / Pressure(Bar)	40	40
装机功率 / Power(kW)	60	90
排气出口尺寸 / Outlet size	DN40	DN40
冷却水进出口尺寸 / The inlet and outlet size of cooling water	DN40	DN40
重量 / Weight (kg)	4000	5500
外形尺寸 / Dimension(mm)	4900*1750*2380	4900*1750*2380

AIR COMPRESSOR

L系列中高压无油压缩机 Medium and High pressure oil free compressor L series

启动——0至低频时电机启动电流小，启动电流小对电网冲击小。

运行——低频至满频运行是由用气量决定，根据用户设定压力值变频器会变频稳定控制在用户设定的压力值工作，达到节能效果。

Starting——0 to low frequency, the start current is small, which has little impact on the power grid.

Loading——Low frequency to full frequency variation is determined by gas consumption, as per set pressure, the converter would be working stable to achieve energy



技术参数 Technical Parameters

型号 / Models	LHW-09/40	LHW-10/40	LHW-12/40
排气量 / Flow rate(m ³ /min)	9	10	12
排气压力 / Pressure(Bar)	40	40	40
装机功率 / Power(kW)	90	110	132
排气出口尺寸 / Outlet size	DN40	DN40	DN40
冷却水进出口尺寸 /The inlet and outlet size of cooling water	DN40	DN40	DN40
重量 / Weight (kg)	5600	5800	6000
外形尺寸 / Dimension(mm)	4900*1750*2380	4900*1750*2380	4900*1750*2380

外形尺寸 Dimension

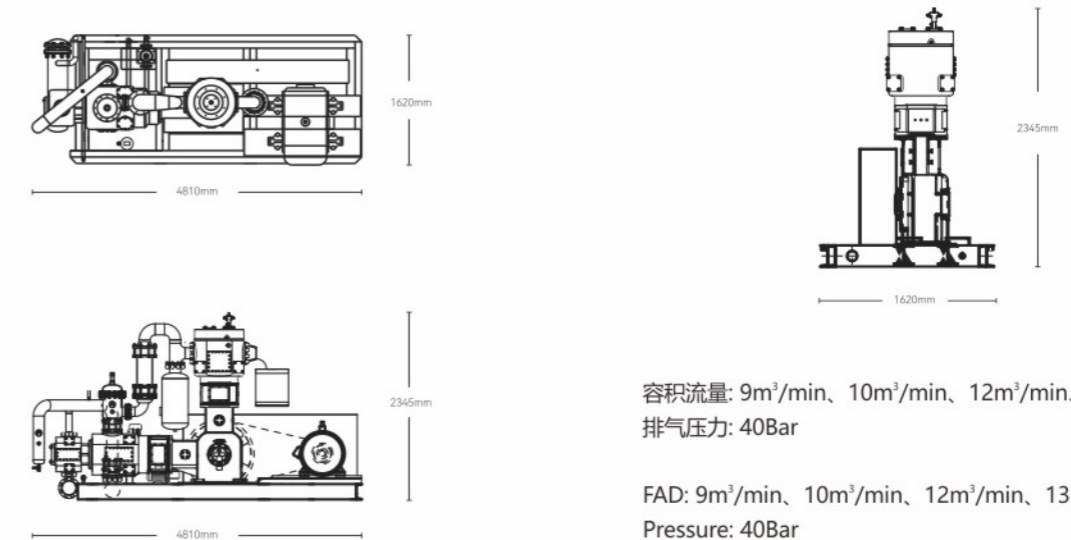

容积流量: 9m³/min、10m³/min、12m³/min、13m³/min
排气压力: 40Bar

FAD: 9m³/min、10m³/min、12m³/min、13m³/min
Pressure: 40Bar



AIR COMPRESSOR

L系列中高压无油压缩机
Medium and High pressure oil free compressor L series

爱木森智能变频控制系统——更节能。

Airmusen intelligent frequency variable control system——saving more energy.

- 启动电流比常规变频更小 Lower start current
- 启动速度比常规变频更快 Faster start speed
- 启动电流小于额定电流 Start current is less than rated current

外形尺寸 Dimension

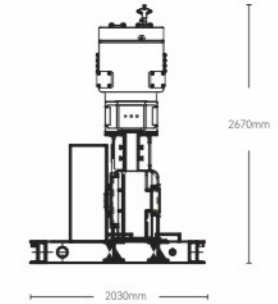
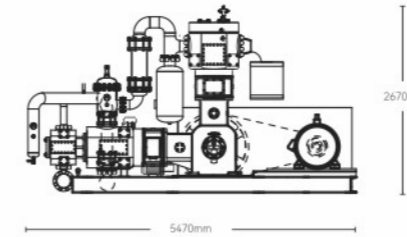
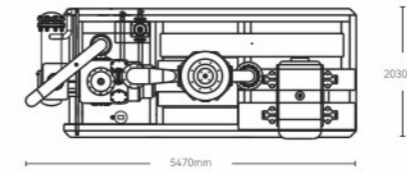

容积流量: 16m³/min、18m³/min、20m³/min
排气压力: 40Bar

FAD: 16m³/min、18m³/min、20m³/min
Pressure: 40Bar

技术参数 Technical Parameters

型号 / Models	LHW-16/40	LHW-18/40	LHW-20/40
排气量 / Flow rate(m ³ /min)	16	18	20
排气压力 / Pressure(Bar)	40	40	40
装机功率 / Power(kW)	160	185	200
排气出口尺寸 / Outlet size	DN50	DN50	DN50
冷却水进出口尺寸 / The inlet and outlet size of cooling water	DN50	DN50	DN50
重量 / Weight (kg)	7400	7500	7600
外形尺寸 / Dimension(mm)	5500*2200*2780	5500*2200*2780	5500*2200*2780

Half load frequency variable is more energy saving

半载变频系统控制器让无油机更节能

半载系统控制技术(用户选配)。

变频与半载的完美结合——运行成本更低。

变频器可以使运行能耗减少1/2，半载功能又可以将总的能耗降至满载的1/4。

Half load control system technology (for optional).

Frequency variable and half load perfect combination——lower operation cost.

The frequency converter can reduce operating energy consumption by half, and half load function can even reduce the total energy consumption to 1/4 of full load.

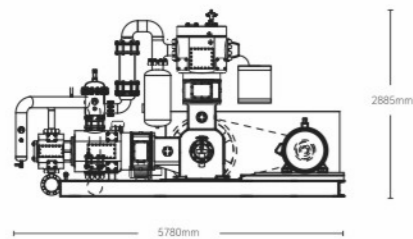
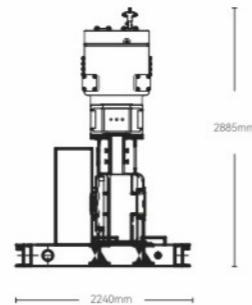
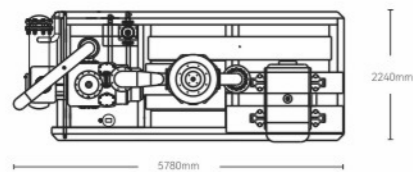

容积流量: 22m³/min、25m³/min、28m³/min、30m³/min
排气压力: 40Bar

FAD: 22m³/min、25m³/min、28m³/min、30m³/min
Pressure: 40Bar

AIR COMPRESSOR

L系列中高压无油压缩机

Medium and High pressure oil free compressor L series



技术参数 Technical Parameters

型号 / Models	LHW-22/40	LHW-25/40	LHW-28/40	LHW-35/40
排气量 / Flow rate(m ³ /min)	22	25	28	35
排气压力 / Pressure(Bar)	40	40	40	40
装机功率 / Power(kW)	220	250	280	355
排气出口尺寸 / Outlet size	DN50	DN50	DN50	DN50
冷却水进出口尺寸 /The inlet and outlet size of cooling water	DN50	DN50	DN50	DN50
重量 / Weight (kg)	7800	8500	8800	9500
外形尺寸 / Dimension(mm)	5500*2200*2780	5800*2250*2980	5800*2250*2980	5800*2250*2980

技术参数 Technical Parameters

型号 / Models	DLW-10/10	DLW-14/10	DLW-16/10	DLW-18/10
排气量 / Flow rate(m³/min)	10	14	16	18
排气压力 / Pressure(Bar)	10	10	10	10
装机功率 / Power(kW)	75	110	110	132
排气出口尺寸 / Outlet size	DN40	DN50	DN50	DN50
冷却水进出口尺寸 /The inlet and outlet size of cooling water	DN40	DN50	DN50	DN50
重量 / Weight (kg)	5000	6500	6600	6800
外形尺寸 / Dimension(mm)	4500*1750*2380	4950*2200*2780	4950*2200*2780	4950*2200*2780

结构简单，方便维护

Simple structure, easy to maintain

外置独立油泵，在启动先进行整机运动部件系统润滑，让每个运动部件注入润滑油后再进行主机启动。

External independent oil pump, which lubricates the moving parts of the entire machine system before starting, allowing each moving part to be injected with lubricating oil before starting the air-end.

整机采用L型设计，行程长，结构简单，上面有两个十字头组件，两个连杆及轴承，第三级无活塞杆填料，更利于第三级高压气体的密封。十分便于维保。

The compressor adopts L-shaped design, long stroke, simple structure, there are two cross head assembly, two connecting rod and bearing, the third stage, which is more conducive to the sealing of the third stage high-pressure compressed air, very convenient for maintenance.

设计特点是在1级运行时使用了垂直自由落体运动，从而可以大大降低能耗，因为一级的运行电费将会占到整体运行费用中45%以上。垂直运行可以减少活塞环等和钢壁的自身重量的摩擦，可以延长零件的使用寿命。

The feature of the design is the use of vertical free fall motion in Stage 1 operation, which can greatly reduce the energy consumption, as the electricity cost of Stage 1 operation will account for more than 45% of the overall operating cost. Vertical operation can reduce the friction between the piston ring and the steel wall's own weight, and can extend the service life of parts.

AIR COMPRESSOR

L系列低压无油压缩机

Medium and High pressure oil free compressor L series

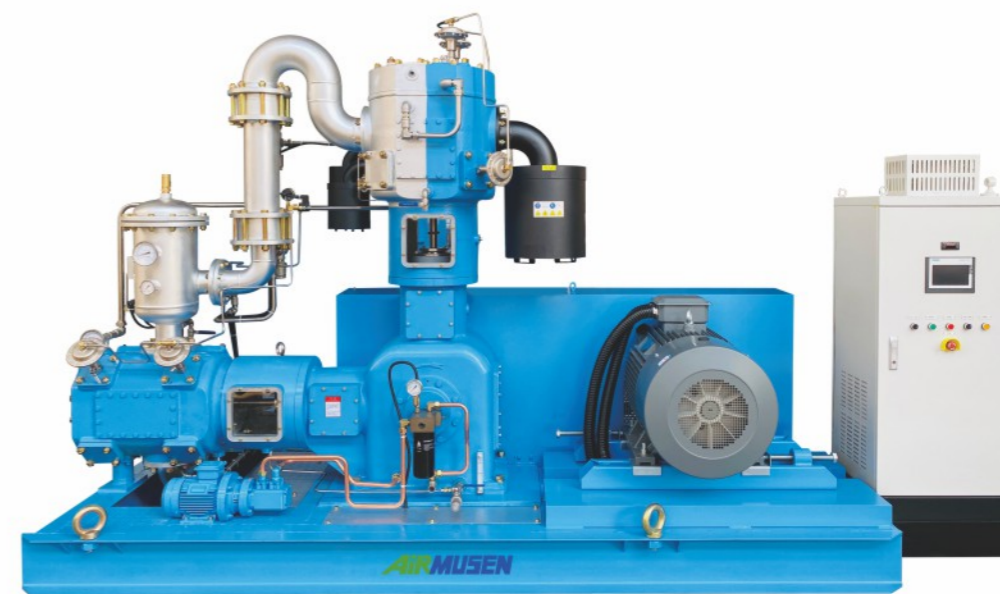

技术参数 Technical Parameters

型号 / Models	DLW-20/10	DLW-22/10	DLW-25/10	DLW-30/10
排气量 / Flow rate(m³/min)	20	22	25	30
排气压力 / Pressure(Bar)	10	10	10	10
装机功率 / Power(kW)	132	160	160	185
排气出口尺寸 / Outlet size	DN50	DN50	DN50	DN50
冷却水进出口尺寸 /The inlet and outlet size of cooling water	DN50	DN50	DN50	DN50
重量 / Weight (kg)	7000	7200	7700	8200
外形尺寸 / Dimension(mm)	4950*2200*2780	4950*2200*2780	5500*2250*2980	5500*2250*2980